



Newland

SCANNING MADE SIMPLE



NQuire 800 III Opah tablet user guide

Thank You.

Thank You for choosing the NQuire800-III as your new tablet.

This quick-start user guide will help you to get to know your new tablet and explain how to get the most out of all of its great features.

Contents.

Important safety information.	5	Accessing the Action center	13
Product overview.	6	Using Cortana	14
Instructions for use.	8	The Date/Time	14
Check the package contents	8	The back button	15
Charging your tablet.	8	Using the On Screen Keyboard (OSK)	15
Rechargeable Lithium-ion Battery	8	Hot Key Shortcuts (Optional)	15
Using your tablet.	8		
Turning your tablet on	8		
Putting your tablet into Sleep Mode	8		
Turning your tablet off	8		
Emergency reboot	9		
Increasing and decreasing the volume	9		
Using headphones with your tablet	9		
Installing a Micro SD card	9		
Installing a Micro SIM card	9		
Using the Stylus	10		
Scanning .	10		
NFC Reading Testing .	10		
Using the touch screen.	10		
Unlocking the screen	10		
The main home screen	10		
Changing between Tablet and PC mode	11		
The Windows home button	12		
Opening and closing apps	12		
Switching apps	12		
Accessing the main menu	13		
		Technical information.	16
		General information.	18
		Guarantee	18
		Disclaimer	18
		Trademarks	18
		Recycling	18
		Disposal of Waste Electrical & Electronic Equipment (WEEE)	18
		Digital Rights Management	19
		Rechargeable Lithium-Ion Battery	19
		Battery and Charger Safety	19
		Small children	19
		Medical devices	19
		Implanted medical devices	19
		Hearing	20

Important safety information.

Your tablet should be treated with care. The information below has been provided in the interest of safety and will help you to enjoy this product and the benefits it brings for many years.

- **DO NOT** use or press down on the tablet PC screen with any sharp objects, they may scratch the LCD screen.
- **DO NOT** place the tablet PC on uneven or unstable work surface.
- Avoid any heavy impacts caused by collisions or dropping your tablet above 1.2 metres as this may damage the product.
- **DO NOT** shove any foreign objects into the Tablet PC.
- **DO NOT** expose the tablet PC to strong magnetic or electrical fields
- **DO NOT** expose the tablet to direct sunlight, or leave the Tablet PC facing the sun for long periods of time as it can damage the LCD Screen.
- **SAFE TEMP:** This tablet PC should only be used in environments with ambient temperatures between 0°C and 40°C
- **CAUTION:** Risk of explosion if battery is replaced by an incorrect type. Dispose of used batteries according to the instructions.
- **DO NOT** throw the Tablet PC in municipal waste. Check local regulations for disposal of electronic products.
- **DO NOT** use harsh chemicals, cleaning solvents or detergents to clean the product. Wipe with a dry soft cloth or tissue paper to clean.
- The underneath and sides of the product may become warm after a long period of use. This is normal.
- **DO NOT** leave the Tablet PC on your lap or any part of the body in order to prevent discomfort or injury from heat exposure.
- **INPUT RATING:** Refer to the rating label on the Tablet PC and be sure that the Power Adapter complies with the rating. Only use attachments or accessories specified by the manufacturer.
- Checking the connections between the main unit and attachments before turning on the Tablet PC.
- **DO NOT** insert anything into the Tablet PC that may result in short circuit or damage the circuit.
- Disconnect the Tablet PC from the electrical outlet and remove any installed batteries before cleaning.
- Keep the product and all of its part out of the reach of children.
- This product is not intended for use by persons (including children) with reduced physical, sensory or mental capabilities, or lack of experience and knowledge, unless they have been given supervision or instruction concerning the use of the appliance by a person responsible for their safety.
- **NEVER** use the tablet near emergency/intensive care medical equipment, if you have a pacemaker fitted or during an electrical storm.
- **CAUTION:** This Tablet PC has some metal parts to disperse heat.
- **DO NOT** block or cover slots, holes or openings on the product by placing on soft furnishings such as carpets, rugs or beds as these are provided for functionality and/or ventilation to ensure safe operation of the product.
- To prevent possible hearing damage, do not listen at high volume levels for long periods.
- **DO NOT** leave it in low temperatures as moisture can form inside the product, which may damage the circuit board.
- **DO NOT** leave it in high temperatures as electronic devices and plastic parts may warp in heat.
- Disconnect your tablet from the mains power supply during thunderstorms.
- Only use the power supply that came with the product. Using an unauthorised power supply will invalidate your guarantee and may irrecoverably damage the product.
- **CAUTION:** When the mains power plug or an appliance coupler is used and then disconnected, the tablet PC shall remain with an electronic charge until power is drained.
- **DO NOT** attempt to open the product. This product does not contain any user serviceable parts. Unauthorised handling of the device may damage it and will void your warranty.

Product overview.

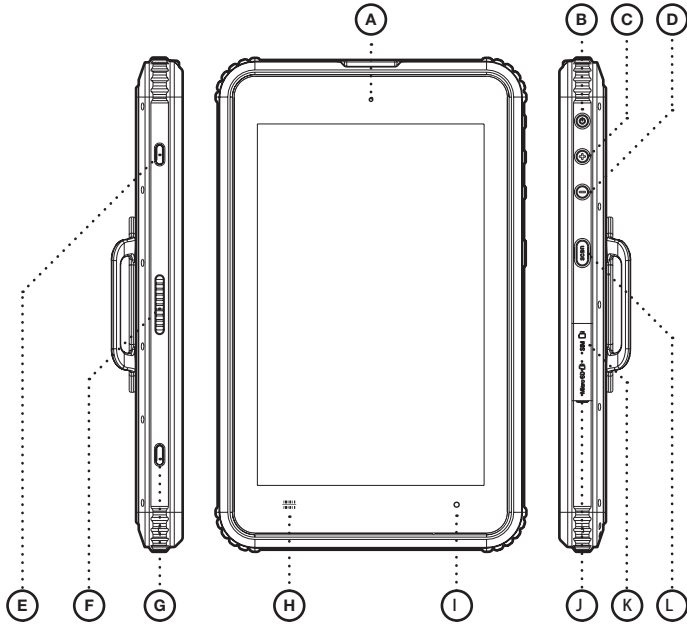

Specification.

A	Power Indicator LED
B	Power/Sleep Button
C	Volume Up
D	Volume Down
E	Docking Mount Point
F	Pogo Pin Connector
G	Docking Mount Point

H	Scan Hotkey (Optional)
I	Keyboard Hotkey
J	Micro SD Slot (Behind Cover)
K	Micro SIM Slot (Behind Cover)
L	Scan
M	Scanner Module

Product overview.

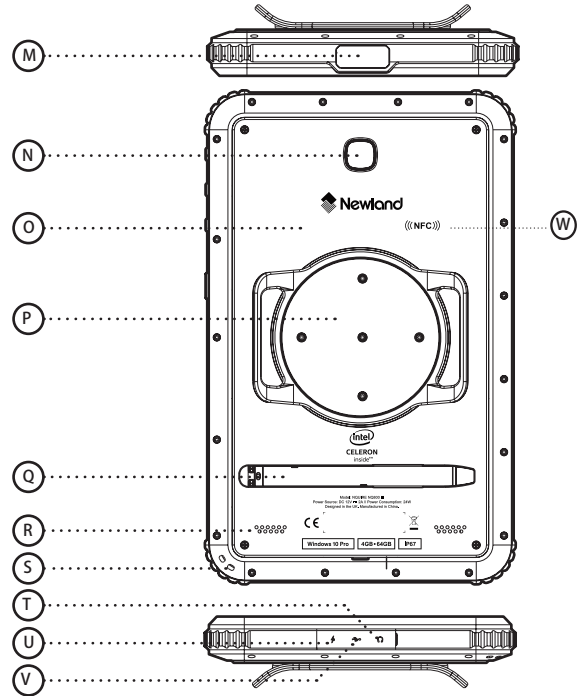

Specification.

N	5.0 Megapixel (MP) CMOS Camera
O	Backplate
P	Rotating Hand Strap Panel (Optional)
Q	Stylus
R	Loudspeaker

S	Lanyard Point
T	3.5mm Headphone Socket (Behind Cover)
U	Charge Point (Behind Cover)
V	Micro USB Type-B (Behind Cover)
W	NFC

Instructions for use.

Check the package contents.

The package contains:

- 1 x NQuire800-III Tablet
- 1 x Power Supply Unit with Mains Plug Adaptor
- 1 x USB OTG Cable
- 1 x User Guide
- 1 x Hand Strap Panel (pre-assembled on Rotating Hand Strap Panel) (Optional)

Charging your tablet.

Your battery has been partially charged at the factory, but you may need to recharge it before you can switch the tablet on for the first time.

Note: It is recommended to recharge the battery of the tablet fully before turning on for the first time.

 **Important:** Use only the provided or approved chargers or cables with this tablet.

1. Plug the charger into a wall outlet
2. Connect the mains charger to your tablet via the connector on the charger. The Power indicator LED will light up when charging.

When the battery is full, disconnect the charger from the tablet, then from the wall outlet.

Note: To check the current charge level of the battery, press the  icon located at the bottom right of the screen.

Note: You don't need to charge the tablet for specific length of time, and you can use the tablet while it is charging.

Note: If the battery is completely discharged, it may take several minutes before the tablet can be used.

Rechargeable Lithium-Ion battery

Your tablet has an internal Lithium-ion polymer battery which should last the lifetime of the product.

If you suspect that the battery is dead, try charging it several times and follow the steps for charging your tablet.

- Do **NOT** attempt to change the battery yourself.
- **CAUTION:** Danger of explosion if batteries are incorrectly replaced.
- **NEVER** use or charge the battery if it appears to be leaking, discoloured, deformed or in any way abnormal.
- **NEVER** expose the battery to any liquid.
- **NEVER** expose the battery to excessive heat such as direct sunlight or fire.
- **NEVER** throw batteries in a fire or attempt to open the outer casing.
- Batteries are harmful if swallowed, so keep away from and out of reach of infants and young children.

Using your tablet.

Turning your tablet On

To turn your tablet on, press and hold the Power/Sleep button and the tablet will begin to power up.

Putting your tablet into Sleep mode

To put your tablet into Sleep mode, press the Power/Sleep button once. The screen should switch off and your tablet will be in Sleep mode.

To wake the tablet from Sleep mode, press the Power/Sleep button once. The screen should wake up and display the lock-screen.

Turning your tablet Off

To turn your tablet off, press **and hold** the Power/Sleep button until you are prompted with the 'Slide to shut down your PC' message. Slide and drag your finger down the screen to begin the shut down process and turn off your tablet.

Emergency reboot

To reboot your tablet if the screen becomes unresponsive, press **and hold** the Power/Sleep button for 10 seconds until the screen turns off.

Note: Leave the tablet for 15 seconds before trying to reboot the tablet.

 **Important:** Avoid powering the tablet down by using the emergency reboot where possible. Always try to shut down your tablet using the correct shut down method to avoid loss or damage to data.

Increasing and decreasing the volume

To increase the volume level on your device, press the Volume up button. Repeatedly press the Volume up button until the desired volume is reached.

To decrease the volume level on your device, press the Volume down button. Repeatedly press the Volume down button until the desired volume is reached.

Using headphones with your tablet

You can connect headphones with a 3.5mm plug (not included) to your tablet. The headphone socket can be found on the bottom of the device highlighted with . When you have headphones connected the tablet speaker is switched off and all sound is via the headphones.

Installing a Micro SD card

Your tablet supports Micro SD cards (not included)

for additional storage of data and files.

 **Important:** Use only compatible memory cards approved for use with this device. Incompatible cards may damage both the memory card and the tablet and may corrupt data stored on the card.

To install a Micro SD memory card:

1. Locate the Micro SD card slot on the tablet.
2. Insert the Micro SD card into the slot with the gold contacts facing up, carefully slide the memory card into the slot, pushing gently until it clicks into place.

Note: To remove a memory card, push the memory card gently until it clicks and the spring will push the card out to allow you to remove it from the tablet.

 **Important:** Do not remove a memory card when files are currently being used by the tablet. This may corrupt or lose the data stored on the memory card.

Installing a Micro SIM Card

Your tablet supports Micro SIM cards for 4G connectivity (where available).

 **Important:** 4G Ready Micro SIM cards and data plans are sold separately and may be subject to additional contracts and fees. Contact your network operator for advice regarding connectivity or network charges.

 **Important:** Please ensure that your tablet is turned off before installing or removing a Micro SIM card.

To install a Micro SIM card:

1. Locate the Micro SIM card slot on the tablet.
2. Insert the Micro SIM card into the slot facing

up and carefully slide the SIM card into the slot, pushing gently until it clicks into place.

To remove a Micro SIM card:

1. Locate the Micro SIM card slot on the tablet.
2. Gently push the installed Micro SIM card until it clicks. A spring will push the SIM card out slightly ready to be removed.

Using the Stylus

The NQuire Tough Tab 8 comes with a Built-in capacitive Stylus providing precision navigation and is designed to aid the function of any workforce.

The stylus can be removed, simply being unclipped from the location slot on the back of the device. Please ensure you take care when removing/storing the stylus.

Note: Please take care when handling the Stylus as incorrect operation/excessive force may damage the tablet or stylus.

Scanning.

This device is equipped with a scan module which is simple to operate.

Instructions:

Press the physical scan button on the side of the Tablet PC or the scan button on Touch Panel on the front bezel, then the scan module will enter the scan mode.

NFC Reading .

This Device is equipped with a NFC module which will allow you to quickly and easily scan the data stored in NFC tags.

Instructions:

Ensure that the correct software for the NFC tag has been installed and start the application to open NFC reading software.

Some NFC reading applications may automatically detect NFC tags and read the information without needing to interact further with the tablet, whereas some may involve pressing buttons on the Touch Panel to begin scanning.

For instructions on setting up and using the NFC reading software, please consult the website of the software manufacturer for support and troubleshooting.

Using the touch screen

Unlocking the screen

To unlock your tablet, press the Power/Sleep button once to wake from sleep mode. When the lock-screen is displayed, slide the screen up to unlock.

The main home screen

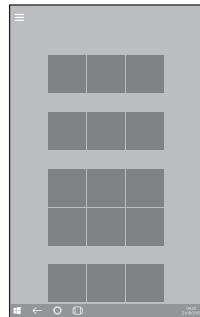

The main home screen is where all of the main applications tiles for your tablet will be located. From here you can select applications to run or open further menus to browse your files.

Note: The main home screen may differ if your tablet is set to 'PC' mode. Please see '**Changing between Tablet and PC mode**' section for more details.

Changing between Tablet and PC mode

Windows 10 can be used in either Tablet mode or PC mode.

Tablet mode is enhanced for smaller touchscreen devices and is optimised to give the best Windows experience when used on tablets.

PC Mode provides users with a 'traditional' PC desktop experience including the Windows 'Start Menu' and file storage on your desktop.

To switch between Tablet and PC Mode:

1. Slide in from the right side of the screen

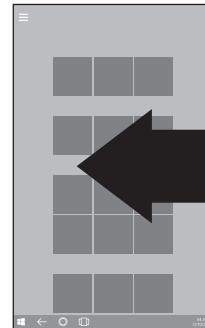

The Action center will now slide in from the right side of the screen:

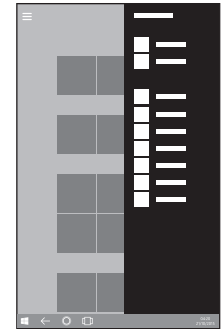

2. To choose between Tablet and PC mode, tap the 'Tablet Mode' tile located at the bottom left of the Action center:

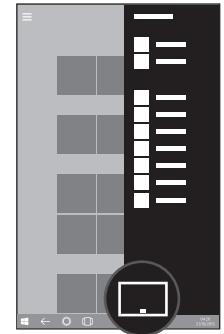

The Windows home button

The Windows home button is used to take you back to the main home screen at any time.

This function can be accessed by **pressing the Windows icon located in the bottom-left of your tablet screen:**

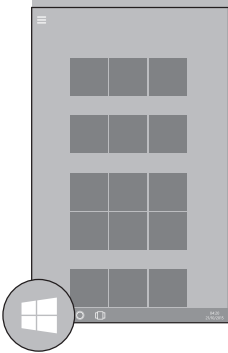

Opening and closing apps

To open an app, tap the app tile.

To close an app, slide your finger down from the top of the screen to the bottom of the screen:

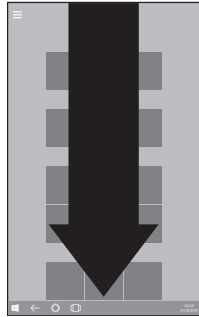

Switching apps

To switch between apps, swipe in from the left edge of the screen:

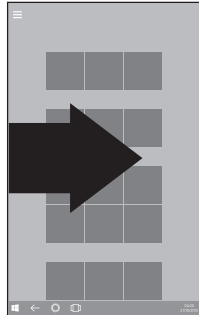

The screen will change to now display all of the applications currently running on your tablet:

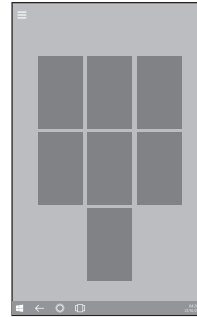

To change to a different app, simply tap the tile of the app that you wish to switch to.

Accessing the main menu

To access the main menu, tap the menu icon located in the top-left of the screen:

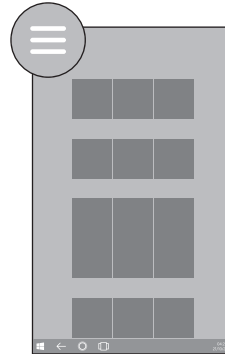

The main menu will now slide in from the left side of the screen:

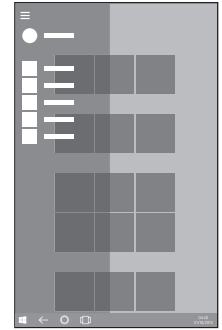

Accessing the Action center

To access the Action center, slide in from the right side of the screen:

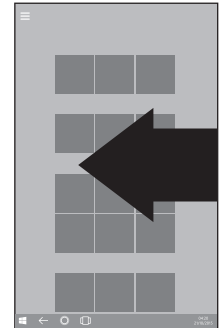

The Action center will now slide in from the right side of the screen:

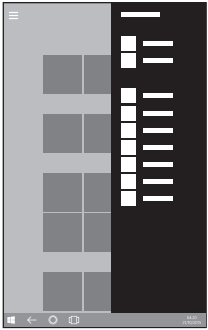

Using Cortana

To use Cortana, tap the Cortana logo located at the bottom of the screen:

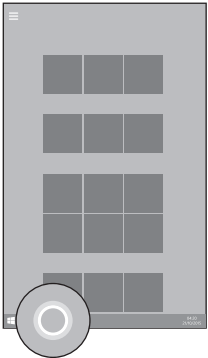

When prompted, speak into the microphone to interact with Cortana.

Note: Cortana can help you with many tasks,

some of which include; Setting up a reminder, Searching the web for information and Check the latest weather forecasts.

The Date/Time

The current date and time are located at the bottom right of the screen:

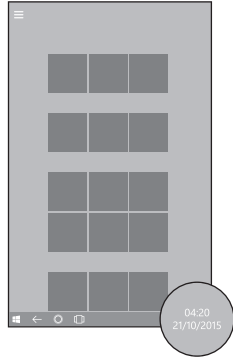

For additional options like changing the settings, press on the Date/Time and an extra menu should pop up.

The back button

The back button takes you back to the previous menu or screen by tapping the 'back' arrow located at the bottom left of the screen:

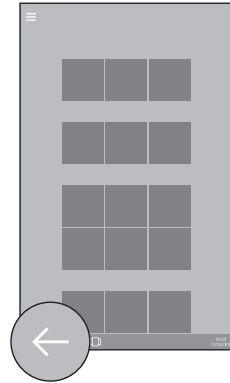

Using the On Screen Keyboard (OSK)

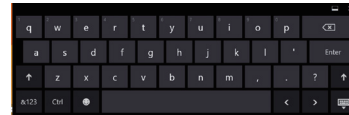

To gain access to the keyboard simply touch a text field to open the on-screen keyboard.

With the OSK you can get access to the numbers by pressing the numbers symbol at the bottom left or simply by tapping the target number key and sliding upwards.

Hot Key Shortcuts (Optional)

The NQuire Tough Tab 8 multi-touch capacitive display comes equipped with additional icons for

application shortcuts located on the screen bezel on the front of your tablet.

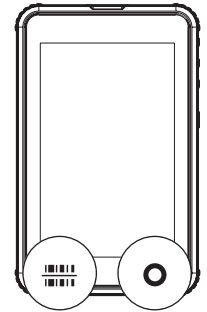

Barcode Scanner

Using the scan button located on the front left-hand side of the touch panel, enables users to operate the scanner that is positioned on top of the device.

On Screen Keyboard (OSK)

By pressing the circular icon on the front right-hand side of the touch panel opens up the tablets on screen keyboard, press again to remove the on screen keyboard.

Note: Buttons will only work when the tablet is unlocked.

Technical information.

Physical Properties.	
Dimensions (HWD)	235 x 147 x 22mm
Weight	860g (Typical)
Primary Orientation	Portrait
Screen Size	8.0" (diagonal)
Screen Resolution / Aspect Ratio	800 x 1280 / 10:16
Touch Module	10-Point Capacitive Touch Panel
Battery Type	Rechargeable Lithium-ion Polymer
Battery Capacity	4.000 mAh / 7.4V
Battery Life	5 - 7 Hours / Approx. (Dependent on use)
IP67 Certified	Dustproof, Waterproof (Submersion up to 1m for 30mins)
Drop Tested	Tested to IEC-60068232 standards at 1.2m
System Hardware Configuration.	
CPU Type	Intel Intel® Celeron® N4120
Clock Speed	1.1 GHz up to 2.6 GHz, 64-Bit Quad Core
RAM	4GB DDR4
ROM Flash	64GB Emmc
Camera	5.0 Megapixel (MP) CMOS (Rear)
Speaker(s)	2 x Built-in 8Ω / 0.8W Speakers
G-Sensor	Gravity Acceleration Sensor
Microphone	Built-in
Navigation	Built-in GPS & GLONASS

Technical information.

Network Connections.	
Wi-Fi	802.11 b/g/n/ac, 2.4Ghz and 5Ghz
Bluetooth Version	Bluetooth 5.0
Interface Configuration.	
Expandable Memory Slot	Supports SDHC / SDXC up to 32GB
USB	1 x Micro USB
Headphone Jack	3.5mm Headphone Port
Keyboard Support	USB, Bluetooth Wired / Wireless
Mouse Support	USB, Bluetooth Wired / Wireless
Included Accessories.	
Power Adaptor	PSU ((12V/2A))
USB Patch Cord	USB OTG Cable
Software Configuration.	
Operating System	Windows 10 Pro

Note: Specifications and external appearance are subject to change without notice.

General information.

Guarantee

Newland Europe BV warrants to the end user that this product will be free from defects in materials and workmanship in the course of normal use for a period of 24 months (2 year) from the date of purchase. This guarantee covers breakdowns due to manufacturing or design faults.

The guarantee is subject to the following provisions:

- The guarantee does not cover accidental damage, however caused, wear and tear, or negligence.
- The guarantee will be rendered invalid if the product is re-sold or is damaged through any adjustment, modification or repair not authorised by us.
- Specifications are subject to change without notice.
- The manufacturer disclaims any liability for the incidental or consequential damages.
- The guarantee is in addition to and does not diminish your statutory or legal right.

Should you have a problem with your unit please contact your supplier or contact Newland EMEA HQ at:

+31 (0)345 87 00 33

Or email us at:
saleservice@newland-id.com

Guarantor:
Newland Europe BV
Rolweg 25
4104AV Culemborg
The Netherlands

Disclaimer

Newland Europe BV makes no representation or warranties with respect to the content of this document and specifically disclaims any implied warranties of merchantability or fitness for any particular purpose. Further, Newland Europe BV reserves the right to revise this, or any other, publication and to make changes to the contents from time to time without the obligation of Newland Europe BV to notify any person or organisation of such revision or changes.

Trademarks

Newland, the Newland logo, NQuire, and the NQuire logo are trademarks or registered trademarks of Newland Europe BV.

Recycling

Always return your used electronic products, batteries, and packaging materials to dedicated collection points. This way you help to prevent uncontrolled waste disposal and promote the recycling of materials. All materials of the device can be recovered as material and energy.

Disposal of Waste Electrical & Electronic Equipment (WEEE)



This symbol on the product or on its packaging indicates that this product should not be treated as household waste. Instead it should be handed over to a suitable collection point for the recycling of electrical and electronic equipment. By ensuring this product is disposed of correctly, you will help prevent potential negative consequences for the environment and human health, which could otherwise be caused by inappropriate waste handling of this product. The recycling of materials will help to conserve natural resources. For more

information about the recycling of this product, please contact your local council office, your household waste disposal service or the shop where you purchased the product.

Digital Rights Management

When using this device, obey all laws and respect local customs, privacy and legitimate rights of others, including copyrights. Copyright protection may prevent you from copying, modifying, or transferring photos, music, and other content.

Rechargeable Lithium-Ion battery

This device has an internal, non-removable, rechargeable Lithium-ion polymer battery. Do not attempt to open the back cover or remove the battery, as you may damage the device. To replace the battery, take the device to the nearest authorised service facility.

Only use the power supply that came with the product. Using an unauthorised power supply could invalidate your guarantee and may irreversibly damage the product.

The battery can be charged and discharged hundreds of times, but it will eventually wear out. When battery life is noticeably shorter than normal, to replace the battery, take the device to the nearest authorised service facility.

Battery and charger safety

To unplug a charger or an accessory, hold and pull the plug, not the cord.

When your charger is not in use, unplug it.

If your tablet is left unused on standby, a fully charged battery will still lose its charge over time.

Always keep the battery between 59°F and 77°F (15°C and 25°C) for optimal performance. Extreme temperatures reduce the capacity and lifetime of the battery. A device with a hot or cold battery may not work temporarily.

Do not dispose of batteries in a fire as they may

explode. Obey local regulations. Recycle when possible. Do not dispose as household garbage. Do not dismantle, cut, crush, bend, puncture, or otherwise damage the battery in any way. If a battery leaks, do not let liquid touch skin or eyes. If this happens, immediately flush the affected areas with water, or seek medical help.

Do not modify, attempt to insert foreign objects into the battery, or immerse or expose it to water or other liquids. Batteries may explode if damaged.

Use the battery and charger for their intended purposes only. Improper use, or use of unapproved or incompatible batteries or chargers may present a risk of fire, explosion, or other hazard, and may invalidate any approval of warranty. If you believe the battery or charger is damaged, take it to a service center before continuing to use it. Never use a damaged battery or charger.

Do not charge your device during a lightning storm. Only use the charger indoors.

Small children

Your device and its accessories are not toys. They may contain small parts. Keep them out of the reach of small children.

Medical devices

Operation of radio transmitting equipment, including wireless phones, may interfere with inadequately shielded medical devices' function. Consult a physician or the medical device's manufacturer to determine if it is adequately shielded from external radio energy.

Implanted medical devices

To avoid potential interference, manufacturers of implanted medical devices recommend a minimum separation of 6 inches (15.3 centimeters) between a wireless device and the medical device. Persons who have such devices should:

- Always keep the wireless device more than

6 inches (15.3 centimeters) from the medical device.

- Turn the wireless device off if there is any reason to suspect that interference is taking place.
- Follow the manufacturer directions for the implanted medical device.

If you have any questions about using your wireless device with an implanted medical device, consult your health care provider.

Hearing



Warning: When you use a headset or earphones, your ability to hear outside sounds may be affected. Do not use the headset where it can endanger your safety.

To prevent possible hearing damage, do not listen to audio at high volume levels for extended periods of time.



Newland

SCANNING MADE SIMPLE

Newland EMEA HQ
+31 (0) 345 87 00 33
info@newland-id.com
newland-id.com

Need more info? Contact us or one of
our partners at newland-id.com/partners